

PIER CAP BAR LIST (9 REQ'D)				
MARK	NO.	SIZE	FORM	LENGTH
(EPOXY COATED)				
H1	11	#11	STR.	41'-2"
H2	10	#5	STR.	41'-2"
H3	11	#11	BNT.	44'-4"
H4	10	#4	BNT.	6'-6"
P1	30	#4	BNT.	7'-6"
P2	30	#4	BNT.	7'-10"
S1	100	#5	BNT.	15'-11"
V1	6	#4	BNT.	6'-0"

PIER 1 BAR LIST				
MARK	NO.	SIZE	FORM	LENGTH
(EPOXY COATED)				
CV1	58	#9	BNT.	17'-3"
(NON-EPOXY COATED)				
CS1	2	W20	SPIRAL	178'-0"
PIER 1 DRILLED SHAFTS				
(EPOXY COATED)				
(1) DV1	56	#11	STR.	28'-6"
(1) T1	16	#4	BNT.	16'-8"
(NON-EPOXY COATED)				
(1) DS1	2	W20	SPIRAL	937'-0"

PIER 2 BAR LIST				
MARK	NO.	SIZE	FORM	LENGTH
(EPOXY COATED)				
CV2	58	#9	BNT.	17'-9"
(NON-EPOXY COATED)				
CS2	2	W20	SPIRAL	388'-0"
PIER 2 DRILLED SHAFTS				
(EPOXY COATED)				
(1) D1	58	#9	STR.	15'-6"
(1) DV2	56	#11	STR.	35'-6"
(1) T1	16	#4	BNT.	16'-8"
(NON-EPOXY COATED)				
(1) DS2	2	W20	SPIRAL	1155'-0"

PIER 3 BAR LIST				
MARK	NO.	SIZE	FORM	LENGTH
(EPOXY COATED)				
CV3	58	#9	BNT.	17'-6"
(NON-EPOXY COATED)				
CS3	2	W20	SPIRAL	382'-0"
PIER 3 DRILLED SHAFTS				
(EPOXY COATED)				
(1) D1	58	#9	STR.	15'-6"
(1) DV3	56	#11	STR.	44'-6"
(1) T1	16	#4	BNT.	16'-8"
(NON-EPOXY COATED)				
(1) DS3	2	W20	SPIRAL	1436'-0"

PIER 4 BAR LIST				
MARK	NO.	SIZE	FORM	LENGTH
(EPOXY COATED)				
CV4	72	#9	BNT.	22'-10"
(NON-EPOXY COATED)				
CS4	2	W20	SPIRAL	525'-0"
PIER 4 DRILLED SHAFTS				
(EPOXY COATED)				
(1) D1	72	#9	STR.	15'-6"
(1) DV4	56	#11	STR.	34'-6"
(1) T1	16	#4	BNT.	16'-8"
(NON-EPOXY COATED)				
(1) DS4	2	W20	SPIRAL	1124'-0"

PIER 5 BAR LIST				
MARK	NO.	SIZE	FORM	LENGTH
(EPOXY COATED)				
CV5	72	#9	BNT.	24'-1"
(NON-EPOXY COATED)				
CS5	2	W20	SPIRAL	560'-0"
PIER 5 DRILLED SHAFTS				
(EPOXY COATED)				
(1) D1	72	#9	STR.	15'-6"
(1) DV5	56	#11	STR.	29'-6"
(1) T1	16	#4	BNT.	16'-8"
(NON-EPOXY COATED)				
(1) DS5	2	W20	SPIRAL	968'-0"

PIER 6 BAR LIST				
MARK	NO.	SIZE	FORM	LENGTH
(EPOXY COATED)				
CV6	72	#9	BNT.	21'-5"
(NON-EPOXY COATED)				
CS6	2	W20	SPIRAL	487'-0"
PIER 6 DRILLED SHAFTS				
(EPOXY COATED)				
(1) D1	72	#9	STR.	15'-6"
(1) DV6	56	#11	STR.	39'-6"
(1) T1	16	#4	BNT.	16'-8"
(NON-EPOXY COATED)				
(1) DS6	2	W20	SPIRAL	1280'-0"

PIER 7 BAR LIST				
MARK	NO.	SIZE	FORM	LENGTH
(EPOXY COATED)				
CV7	72	#9	BNT.	19'-9"
(NON-EPOXY COATED)				
CS7	2	W20	SPIRAL	441'-0"
PIER 7 DRILLED SHAFTS				
(EPOXY COATED)				
(1) D1	72	#9	STR.	15'-6"
(1)(2) DV7	56	#11	STR.	76'-0"
(1) T1	16	#4	BNT.	16'-8"
(NON-EPOXY COATED)				
(1) DS7	2	W20	SPIRAL	2153'-0"

PIER 8 BAR LIST				
MARK	NO.	SIZE	FORM	LENGTH
(EPOXY COATED)				
CV8	72	#9	BNT.	19'-0"
(NON-EPOXY COATED)				
CS8	2	W20	SPIRAL	422'-0"
PIER 8 DRILLED SHAFTS				
(EPOXY COATED)				
(1) D1	72	#9	STR.	15'-6"
(1)(2) DV8	56	#11	STR.	79'-0"
(1) T1	16	#4	BNT.	16'-8"
(NON-EPOXY COATED)				
(1) DS8	2	W20	SPIRAL	2246'-0"

PIER 9 BAR LIST				
MARK	NO.	SIZE	FORM	LENGTH
(EPOXY COATED)				
CV9	58	#9	BNT.	19'-6"
(NON-EPOXY COATED)				
CS9	2	W20	SPIRAL	240'-0"
PIER 9 DRILLED SHAFTS				
(EPOXY COATED)				
(1)(2) DV9	56	#11	STR.	93'-0"
(1) T1	16	#4	BNT.	16'-8"
(NON-EPOXY COATED)				
(1) DS9	2	W20	SPIRAL	2683'-0"

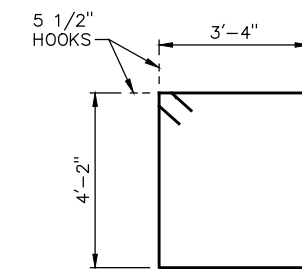
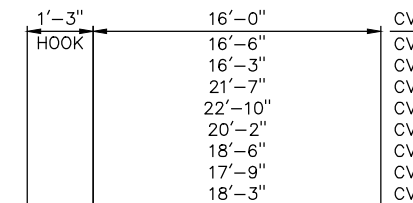

S1 #5 x 15'-11"

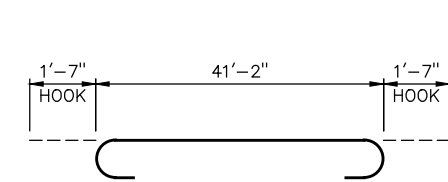

H3 #11 x 44'-4"

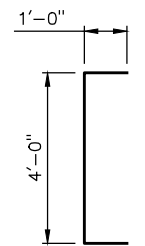

V1 #4 x 6'-0"

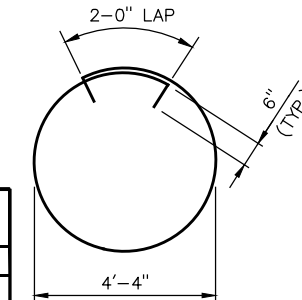

T1 #4 x 16'-8"

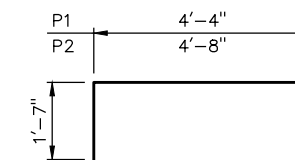

P1 #4 x 7'-6"
P2 #4 x 7'-10"

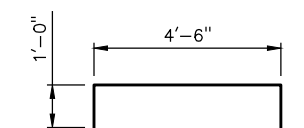

H4 #4 x 6'-6"

BAR BEND DETAILS

PIER QUANTITIES											
ITEM	UNITS	PIER 1	PIER 2	PIER 3	PIER 4	PIER 5	PIER 6	PIER 7	PIER 8	PIER 9	TOTAL
CLASS A CONCRETE	CY	44.70	56.00	55.70	63.40	65.30	61.30	58.80	57.80	48.00	511.00
REINFORCING STEEL	LB	250.00	530.00	520.00	720.00	770.00	670.00	600.00	580.00	330.00	4,970.00
EPOXY COATED REINFORCING STEEL	LB	10,880.00	10,980.00	10,930.00	13,060.00	13,370.00	12,720.00	12,310.00	12,130.00	11,320.00	107,700.00
WATER REPELLENT (VISUALLY INSPECTED)	SY	75.00	75.00	75.00	75.00	75.00	75.00	75.00	75.00	75.00	675.00
DRILLED SHAFTS 72" DIAMETER	LF	58.00	72.00	90.00	70.00	60.00	80.00	136.00	142.00	170.00	878.00
CROSSHOLE SONIC LOGGING	EA	1.00	0.00	1.00	0.00	0.00	1.00	0.00	0.00	1.00	4.00

- ① ESTIMATED QUANTITY ONLY, PER PIER, TO BE USED AS DIRECTED BY THE ENGINEER.

PIER DETAILS

(SHEET 4 OF 4)
BRIDGE "A" C.R.L. STA. 586+80.46